

Introduction

The plbv46_slave_single is a part of Xilinx's family of PLB v4.6 compatible products. It provides a single only bi-directional interface between a User IP core and the PLB v4.6 bus standard. This version of the plbv46_slave_single has been optimized for slave operation on the version 4.6 PLB Bus. It does not provide support for DMA and IP Master Services.

Features

- Compatible with Xilinx PLB v4.6 32, 64 and 128-bit PLB .
- Supports access by 32, 64, and 128-Bit Masters.
- Supports 32-Bit slave Configuration.
- Supports Single Beat read and write data transfers of byte (8-bit), half-word (16-bit), and word (32-bit) widths
- Supports Low latency PLB Point-to-Point topology

LogiCORE™ Facts		
Core Specifics		
Supported Device Family	Virtex-4®, Virtex-5, Spartan®-3E, Automotive Spartan-3E, Spartan-3, Automotive Spartan-3, Spartan-3A, Automotive Spartan-3A, Spartan-3A DSP, Automotive Spartan-3A DSP	
Version of core	plbv46_slave_si ngle	v1.01a
Resources Used		
	Min	Max
Slices	37	88
LUTs	27	59
FFs	91	191
Block RAMs	None	
Provided with Core		
Documentation	Product Specification	
Design File Formats	VHDL	
Constraints File	UCF	
Verification	VHDL Test bench	
Instantiation Template	VHDL Wrapper	
Reference Designs & application notes	None	
Design Tool Requirements		
Xilinx Implementation Tools	ISE® 9.2 or later	
Verification	ModelSim PE 6.3d	
Simulation	ModelSim PE 6.3d	
Synthesis	XST	
Support		
Provided by Xilinx, Inc.		

© 2006-2008 Xilinx, Inc. All rights reserved. All Xilinx trademarks, registered trademarks, patents, and further disclaimers are as listed at <http://www.xilinx.com/legal.htm>. All other trademarks and registered trademarks are the property of their respective owners. All specifications are subject to change without notice.
 NOTICE OF DISCLAIMER: Xilinx is providing this design, code, or information "as is." By providing the design, code, or information as one possible implementation of this feature, application, or standard, Xilinx makes no representation that this implementation is free from any claims of infringement. You are responsible for obtaining any rights you may require for your implementation. Xilinx expressly disclaims any warranty whatsoever with respect to the adequacy of the implementation, including but not limited to any warranties or representations that this implementation is free from claims of infringement and any implied warranties of merchantability or fitness for a particular purpose.

Functional Description

The plbv46_slave_single is designed to provide a User with a quick way to implement light weight interface between the IBM PLB Bus and a User IP core. This slave service allows for multiple User IP's to be interfaced to the PLB bus providing address decoding over various address ranges as configured by the user. Optionally the plbv46_slave_single can be optimized for a point to point connection reducing FPGA resources and improving latency. [Figure 1](#) shows a block diagram of the plbv46_slave_single. The port references and groupings are detailed in [Table 1](#).

The base element of the design is the Slave Attachment. This block provides the basic functionality for slave operation. It implements the protocol and timing translation between the PLB Bus and the IPIC.

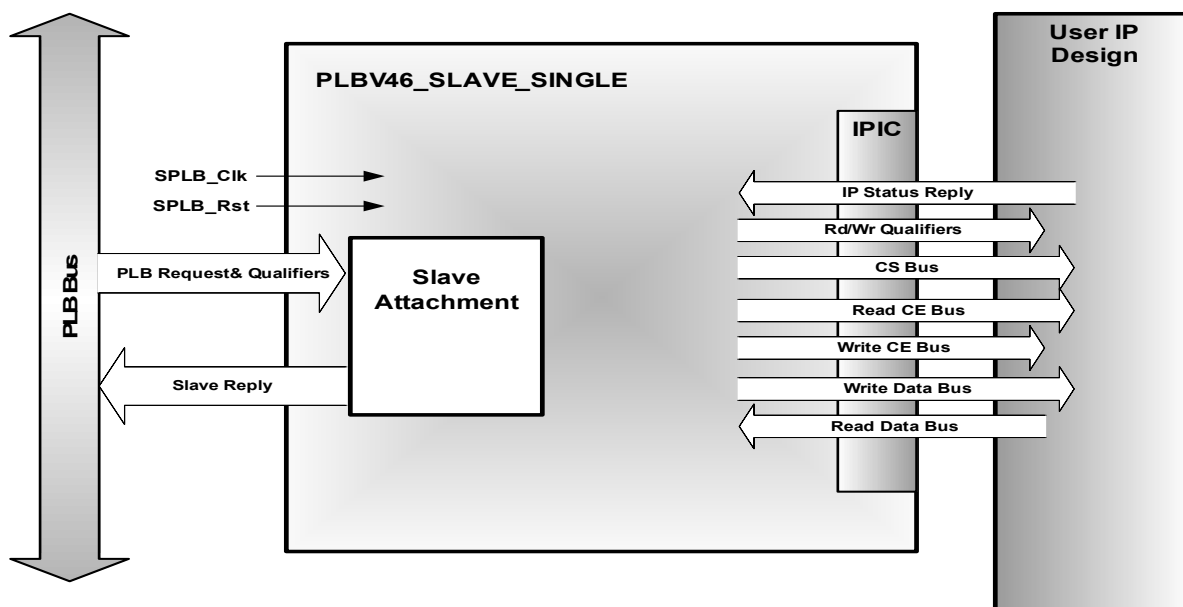

Figure 1: PLBV46_SLAVE_SINGLE Block Diagram

I/O Signals

The plbv46_slave_single signals are listed and described in [Table 1](#).

Table 1: PLBV46_SLAVE_SINGLE I/O Signal Description

Signal Name	Interface	Signal Type	Init Status	Description
PLB Bus Request and Qualifier Signals				
SPLB_Clk	PLB Bus	I		PLB main bus clock. See table note 1.
SPLB_Rst	PLB Bus	I		PLB main bus reset. See table note 1.
PLB_ABus(0:31)	PLB Bus	I		See table note 1.
PLB_PAVValid	PLB Bus	I		See table note 1.
PLB_masterID(0:C_SPLB_MID_WI DTH-1)	PLB Bus	I		See table note 1.
PLB_RNW	PLB Bus	I		See table note 1.

Table 1: PLBV46_SLAVE_SINGLE I/O Signal Description

Signal Name	Interface	Signal Type	Init Status	Description
PLB_BE(0:[C_SPLB_DWIDTH/8]-1)	PLB Bus	I		See table note 1.
PLB_size(0:3)	PLB Bus	I		See table note 1.
PLB_type(0:2)	PLB Bus	I		See table note 1.
PLB_wrDBus(0:C_SPLB_DWIDTH-1)	PLB Bus	I		See table note 1.
SI_addrAck	PLB Bus	O	0	See table note 1.
SI_SSize(0:1)	PLB Bus	O	0	See table note 1.
SI_wait	PLB Bus	O	0	See table note 1.
SI_rearbitrate	PLB Bus	O	0	See table note 1.
SI_wrDack	PLB Bus	O	0	See table note 1.
SI_wrComp	PLB Bus	O	0	See table note 1.
SI_rdBus(0:C_SPLB_DWIDTH-1)	PLB Bus	O	0	See table note 1.
SI_rdDack	PLB Bus	O	0	See table note 1.
SI_rdComp	PLB Bus	O	0	See table note 1.
SI_MBusy(0:C_SPLB_NUM_MASTERS-1)	PLB Bus	O	0	See table note 1.
SI_MWrErr(0:C_SPLB_NUM_MASTERS-1)	PLB Bus	O	0	See table note 1.
SI_MRdErr(0:C_SPLB_NUM_MASTERS-1)	PLB Bus	O	0	See table note 1.
Unused PLB Signals				
PLB_UABus(0:31))	PLB Bus	I		Unused
PLB_SAVValid	PLB Bus	I		Unused
PLB_rdPrim	PLB Bus	I		Unused
PLB_wrPrim	PLB Bus	I		Unused
PLB_abort	PLB Bus	I		Unused
PLB_busLock	PLB Bus	I		Unused
PLB_MSize(0:1)	PLB Bus	I		Unused
PLB_TAttribute(0 to 15)	PLB Bus	I		Unused
PLB_lockerr	PLB Bus	I		Unused
PLB_wrBurst	PLB Bus	I		Unused
PLB_rdBurst	PLB Bus	I		Unused
PLB_wrPendReq	PLB Bus	I		Unused
PLB_rdPendReq	PLB Bus	I		Unused
PLB_rdPendPri(0:1)	PLB Bus	I		Unused

Table 1: PLBV46_SLAVE_SINGLE I/O Signal Description

Signal Name	Interface	Signal Type	Init Status	Description
PLB_wrPendPri(0,1)	PLB Bus	I		Unused
PLB_reqPri(0:1)	PLB Bus	I		Unused
Sl_wrBTerm	PLB Bus	O	0	Unused
Sl_rdWdAddr(0:3)	PLB Bus	O	0	Unused
Sl_rdBTerm	PLB Bus	O	0	Unused
Sl_MIRQ(0:C_SPLB_NUM_MASTERS-1)	PLB Bus	O	0	Unused
User IP Signals				
Bus2IP_Clk	User IP	O	0	Synchronization clock provided to User IP. This is the same as SPLB_Clk.
Bus2IP_Reset	User IP	O	0	Active high reset for use by the User IP. It is a pass through of the SPLB_Rst input.
IP2Bus_Data(0:C_SIPF_DWIDTH-1)	User IP	I		Input Read Data bus from the User IP. Data is qualified with the assertion of IP2Bus_RdAck signal and the rising edge of the Bus2IP_Clk.
IP2Bus_WrAck	User IP	I		Active high Write Data qualifier. Write data on the Bus2IP_Data Bus is deemed accepted by the User IP at the rising edge of the Bus2IP_Clk and the assertion of the IP2Bus_WrAck for 1 clock cycle by the User IP.
IP2Bus_RdAck	User IP	I		Active high read data qualifier. Read data on the IP2Bus_Data Bus is deemed valid at the rising edge of Bus2IP_Clk and the assertion of the IP2Bus_RdAck signal for 1 clock cycle by the User IP.
IP2Bus_Error	User IP	I		Active high signal indicating the User IP has encountered an error with the requested operation. This signal is asserted in conjunction with IP2Bus_RdAck or the IP2Bus_WrAck.

Table 1: PLBV46_SLAVE_SINGLE I/O Signal Description

Signal Name	Interface	Signal Type	Init Status	Description
Bus2IP_Addr(0:C_SPLB_AWIDTH-1)	User IP	O	0	Address bus indicating the desired address of the requested read or write operation.
Bus2IP_Data(0:C_SIPIF_DWIDTH-1)	User IP	O	0	Write data bus to the User IP. Write data is accepted by the IP during a write operation by assertion of the IP2Bus_WrAck signal and the rising edge of the Bus2IP_Clk.
Bus2IP_RNW	User IP	O	0	This signal indicates the sense of a requested operation with the User IP. High is a read, low is a write.
Bus2IP_BE(0:(C_SIPIF_DWIDTH/8)-1)	User IP	O	0	Byte enable qualifiers for the requested read or write operation with the User IP. Bit 0 corresponds to Byte lane 0, Bit 1 to Byte lane 1, and so on.
Bus2IP_CS(0:(C_ARD_ADDR_RANGE_ARRAY'length/2) - 1)	User IP	O	0	Active High chip select bus. Each bit of the bus corresponds to an address pair entry in the C_ARD_ADDR_RANGE_ARRAY. Assertion of a chip select indicates a active transaction request to the chip select's target address space.

Table 1: PLBV46_SLAVE_SINGLE I/O Signal Description

Signal Name	Interface	Signal Type	Init Status	Description
Bus2IP_RdCE(0: see note 2)	User IP	O	0	Active high chip enable bus. Chip enables are assigned per the User's entries in the C_ARD_NUM_CE_ARRAY. These chip enables are asserted only during active read transaction requests with the target address space and in conjunction with the corresponding sub-address within the space.
Bus2IP_WrCE(0: see note 2)	User IP	O	0	Active high chip enable bus. Chip enables are assigned per the Users entries in the C_ARD_NUM_CE_ARRAY. These chip enables are asserted only during active write transaction requests with the target address space and in conjunction with the corresponding sub-address within the space.

Note:

1. This signal's function and timing is defined in the IBM® **128-Bit Processor Local Bus Architecture Specification Version 4.6**.
2. The size of the Bus2IP_RdCE and the Bus2IP_WrCE buses is the sum of the integer values entered in the **C_ARD_NUM_CE_ARRAY**

Design Parameters

The plbv46_slave_single provides for User interface tailoring via VHDL Generic parameters. These parameters are detailed in [Table 2](#).

The FPGA Family Type parameter is used to select the target FPGA family type. Currently, this design supports Virtex-4, Virtex-5 and Spartan-3 family of devices.

Table 2: PLBV46_SLAVE_SINGLE Design Parameters

Feature/Description	Parameter Name	Allowable Values	Default Values	VHDL Type
Decoder Address Range Definition				
Array of Base Address / High Address Pairs for each Address Range	C_ARD_ADDR_RANGE_ARRAY	See "Parameter Detailed Descriptions" on page 9	User must set values.	SLV64_ARRAY_TYPE ⁽¹⁾
Array of the desired number of chip enables for each address range	C_ARD_NUM_CE_ARRAY	See "Parameter Detailed Descriptions" on page 9	User must set values.	INTEGER_ARRAY_TYPE ⁽¹⁾
PLB I/O Specification				
PLB Master ID Bus Width	C_SPLB_MID_WIDTH	log ₂ (C_SPLB_NUM_MASTERS) with a minimum value of 1	3	integer
Number of PLB Masters	C_SPLB_NUM_MASTERS	1 to 16	8	integer
Width of the PLB Least Significant Address Bus	C_SPLB_AWIDTH	32	32	integer
Width of the PLB Data Bus	C_SPLB_DWIDTH	32, 64, 128	32	integer
Selects point-to-point or shared plb topology.	C_SPLB_P2P	0 = Shared Bus Topology 1 = Point-to-Point Bus Topology	0	integer
Selects the ratio of bus clock to core clock for use in dual clock systems.	C_BUS2CORE_CLK_RATIO	1 = Ratio of Bus Clock to Core clock is 1:1 2 = Ratio of Bus Clock to Core Clock is 2:1	1	integer
Slave Attachment I/O Specification				
Width of the Slave Data Bus	C_SIIF_DWIDTH	32	32	integer
Data Phase Timer configuration	C_INCLUDE_DPHASE_TIMER	0 = Exclude data phase timeout timer 1 = Include data phase timeout timer.	1	integer

Table 2: PLBV46_SLAVE_SINGLE Design Parameters

Feature/Description	Parameter Name	Allowable Values	Default Values	VHDL Type
FPGA Family Type				
Xilinx FPGA Family	C_FAMILY	virtex4, virtex5, spartan3a, aspartan3a, spartan3, aspartan3, spartan3e, aspartan3e, spartan3adsp, aspartan3adsp	virtex4	string

Note:

1. This Parameter VHDL type is a custom type defined in the ipif_pkg.vhd.

Parameter - Port Dependencies

Allowable Parameter Combinations

Table 3: PLBV46_SLAVE_SINGLE Parameter-Port Dependencies

Name (Generic or Port)	Affects (Port)	Depends (Generic)	Relationship Description
Design Parameters			
C_ARD_ADDR_RANGE_ARRAY	Bus2IP_CS		The vector width of Bus2IP_CS is the number of elements in C_ARD_ADDR_RANGE_ARRAY/2
C_ARD_NUM_CE_ARRAY	Bus2IP_WrCE		The vector width of Bus2IP_WrCE is the number of elements in C_ARD_NUM_CE_ARRAY
C_ARD_NUM_CE_ARRAY	Bus2IP_RdCE		The vector width of Bus2IP_WrCE is the number of elements in C_ARD_NUM_CE_ARRAY
I/O Signals			
Bus2IP_CS		C_ARD_ADDR_RANGE_ARRAY	The vector width of Bus2IP_CS is the number of elements in C_ARD_ADDR_RANGE_ARRAY/2
Bus2IP_WrCE		C_ARD_NUM_CE_ARRAY	The vector width of Bus2IP_WrCE is the number of elements in C_ARD_NUM_CE_ARRAY
Bus2IP_RdCE		C_ARD_NUM_CE_ARRAY	The vector width of Bus2IP_WrCE is the number of elements in C_ARD_NUM_CE_ARRAY

Parameter Detailed Descriptions

Address Range Definition Arrays

One of the primary functions of the PLBV46 Slave Single is to provide address decoding and Chip Enable/Chip Select control signal generation.

The plbv46_slave_single employs VHDL Generics that are defined as unconstrained arrays as the method for customizing address space decoding. These parameters are called the Address Range Definition (ARD) arrays. There are two of these arrays used for address space definition in the plbv46_slave_single. They can be recognized by the "C_ARD" prefix of the Generic name. The ARD Generics are:

- C_ARD_ADDR_RANGE_ARRAY
- C_ARD_NUM_CE_ARRAY

One of the big advantages of using unconstrained arrays for address decode space description is that it allows the User to specify as few or as many unique and non-contiguous PLB Bus address spaces as the peripheral design needs. The Slave Attachment decoding logic will be optimized to recognize and respond to only those defined address spaces during active PLB Bus transaction requests.

Since the number of entries in the arrays can grow or shrink based on each User Application, the slave attachment is designed to analyze the User's entries in the arrays and then automatically add or remove resources, and interconnections based on the arrays' contents. A special case arises when there is a single entry in an unconstrained

array. Refer to the section titled "[Single Entry in Unconstrained Array Parameters](#)" on page 28 for hints on entering data for this case.

The ordering of a set of address space entries within the ARD arrays is not important. Each address space is processed independently from any of the other address space entries. **However, once an ordering is established in any one of the arrays, that ordering of the entries must be maintained in the other ARD array.** That is, the first two entries in C_ARD_ADRR_RANGE_ARRAY will be associated with the first CE Number entry in the C_ARD_NUM_CE_ARRAY.

C_ARD_ADDR_RANGE_ARRAY

The actual address range for an address space definition is entered in this array. Each address space is by definition a contiguous block of addresses as viewed from the host microprocessor's total addressable space. It's specification requires a pair of entries in this array. The first entry of the pair is the Base Address (starting address) of the block, the second entry is the High Address (ending address) of the block. These addresses are byte relative addresses. The array elements are defined as std_logic_vector(0 to 63) in the ipif_pkg.vhd file in Processor Common (proc_common) library. Currently, the biggest address bus used on the PLB bus is 32 bits. However, 64 bit values have been allocated for future growth in address bus width.

```
C_ARD_ADDR_RANGE_ARRAY : SLV64_ARRAY_TYPE :=
  -- Base address and high address pairs .
  (
    X0000_0000_7000_0000", -- user control reg bank base address
    X0000_0000_7000_0007", -- user control reg bank high address
    X0000_0000_7000_0100", -- user status reg bank base address
    X0000_0000_7000_010F"  -- user status reg bank high address
  )
```

In this example, there are two address pairs entered into the C_ARD_ADDR_RANGE_ARRAY VHDL Generic. This corresponds to the two address spaces being defined by the user . Each pair is comprised of a starting address and an ending address . Values are right justified and are byte address relative .

Figure 2: Address Range Specification Example

The User must follow several rules when assigning values to the address pairs. These rules assure that the address range will be correctly decoded in the Slave Attachment. First, the User must decide the required address range to be defined. The block size (in bytes) must be a power of 2 (i.e. 2, 4, 8, 16, 32, 64, 128, 256 and so on). Secondly, the Base Address must start on an address boundary that is a multiple of the chosen block size. For example, an address space is needed that will include 2048 bytes (0x800 hex) of the system memory space. Valid Base Address entries are 0x00000000, 0x00000800, 0xFFFFF000, 0x90001000, etc. A value of 0x00000120 is not valid because it is not a multiple of 0x800 (2048). Thirdly, the High Address entry is equal to the assigned Base Address plus the block size minus 1. Continuing the example of a 2048 byte block size, a Base Address of 0x00000000 yields a High Address of 0x000007FF; a Base Address of 0x00000800 would require a corresponding High Address value of 0x00000FFF.

C_ARD_NUM_CE_ARRAY

The slave decoding logic provides the User the ability to generate multiple chip enables within a single address space. This is primarily used to support a bank of registers that need an individual chip enable for each register. The User enters the desired number of chip enables for an address space in the C_ARD_NUM_CE_ARRAY. The values entered are positive integers that are powers of 2 (1, 2, 4, 8, 16, 32, and so on). Each address space must have at least 1 chip enable specified. The address space range will be subdivided and sequentially assigned a chip enable based on a data width or 32 bits.

The User must ensure that the address space for a group of chip enables is greater than or equal to the specified width of the memory space in bytes ($32 / 8 = 4$) times the number of desired chip enables.

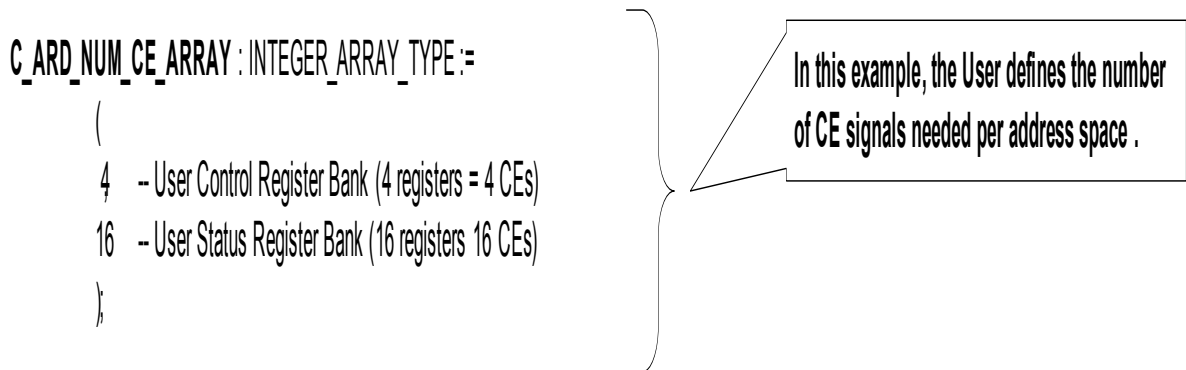

Figure 3: Chip Enable Specification Example

C_SPLB_P2P

This parameter is defined as an integer. Setting this parameter to 0 will configure the plb_slave_single for a plb shared bus application. Setting this parameter to 1 will configure the plb_slave_single for a plb point-to-point bus application. In a point-to-point configuration the slave attachment acknowledges all address cycles on the plb and only address decodes based on the number CE’s configured for the User IP. This reduces some FPGA resources. Latency is also reduced in a point-to-point configuration. **Note: If more than 1 address range is defined in C_ARD_ADDR_RANGE_ARRAY in a point-to-point configuration (i.e. when C_SPLB_P2P = 1) then the slave attachment will instantiate the address decode logic to distinguish multiple address ranges. This will require a small amount of addition FPGA resources to be used. For the least amount of required FPGA resources only define 1 address pair in C_ARD_ADDR_RANGE_ARRAY when C_SPLB_P2P = 1.**

C_BUS2CORE_CLK_RATIO

This parameter sets the clock ratio between the PLB Bus clock and the core clock. Setting this parameter to a 1 will set the ratio to 1:1. Use this setting for cores where the PLB clock is equal to the User IP’s core clock. For situations where the User IP does not need to run at the bus frequency a dual clock system can be established where the User IP can run at 1/2 the PLB clock’s frequency. This can improve fmax for the system. To configure the plbv46_slave_single for this mode of operation set C_BUS2CORE_CLK_RATIO = 2 for a clock ratio of 2:1. In other words the PLB Bus clock is running a 2X the User IP’s core clock.

NOTE: For proper operation the PLB Clock and the Core Clock must be edge synchronous. This can be achieved by driving the PLB Clock and the Core Clock from a DCM.

C_SPLB_MID_WIDTH

This parameter is defined as an integer and has a minimum value of 1. It is equal to \log_2 of the number of PLB Masters connected to the PLB bus or 1, whichever is greater. It is used to size the PLB_masterID bus input from the PLB Bus to the Slave Attachment. For example, if eight PLB Masters are connected to the PLB Bus, then this parameter must be set to $\log_2(8)$ which is equal to 3. The PLB Bus PLB_masterID bus will be sized to 3 bits wide. If only one master exists, then the parameter needs to be set to 1. Also, when C_SPLB_P2P = 1 set C_SPLB_MID_WIDTH = 1.

C_SPLB_NUM_MASTERS

This parameter is defined as an integer and is equal to the number of Masters connected to the PLB bus. This parameter is used to size the SI_MBusy and SI_MErr slave reply buses to the PLB. For example, if eight PLB Masters are connected to the PLB Bus, then this parameter must be set to 8. The SI_MBusy bus and SI_MErr bus will be sized to 8 bits wide each. Also, when C_SPLB_P2P = 1 set C_SPLB_NUM_MASTERS = 1.

C_SPLB_AWIDTH

This integer parameter is used by the PLB Slave to size the PLB address related components within the Slave Attachment. This value should be set 32.

C_SPLB_DWIDTH

This integer parameter is used by the PLB Slave to size PLB data bus related components within the Slave Attachment. This value should be set to match the actual width of the PLB bus, 32, 64 or 128-Bits.

C_SIPIF_DWIDTH

This integer parameter is used to specify the data width of the slave attachment. This parameter is used to interface various width Slave devices with various width PLB Buses. This value is the native width of the slave device and is fixed at 32 for this version of slave attachment.

C_INCLUDE_DPHASE_TIMER

This integer value determines whether or not the data phase timeout timer is included. Setting this value to a 1 will include the data phase timeout timer and setting this value to a 0 will exclude the data phase timeout timer.

C_FAMILY

This parameter is defined as a string. It specifies the target FPGA technology for implementation of the PLB Slave. This parameter is required for proper selection of FPGA primitives. The configuration of these primitives can vary from one FPGA technology family to another.

IP Interconnect (IPIC) Signal Description

Bus2IP_Addr

Bus2IP_Addr is a 32 Bit vector that drives valid when Bus2IP_CS and Bus2IP_RdCE or Bus2IP_WrCE drives high.

Bus2IP_Data

Bus2IP_Data is a vector of width C_SIPIF_DWIDTH and drives valid on writes when Bus2IP_WrCE or Bus2IP_WrReq drive high.

Bus2IP_RNW

Bus2IP_RNW is a signal indicating the type of transfer in progress and is valid when Bus2IP_CS and Bus2IP_WrCE or Bus2IP_RdCE is asserted. A high on Bus2IP_RNW indicates the transfer request is a read of the User IP. A low on Bus2IP_RNW indicates the transfer request is a write to the User IP.

Bus2IP_BE

Bus2IP_BE is a vector of width C_SIPIF_DWIDTH/8. This vector indicates which bytes are valid on Bus2IP_DATA. Bus2IP_BE becomes valid coincident with Bus2IP_CS.

Bus2IP_CS

Bus2IP_CS is a vector of width C_ARD_ADDR_RANGE_ARRAY'length / 2. In other words, for each address pair defined in C_ARD_ADDR_RANGE_ARRAY there is 1 Bus2IP_CS defined. This signal asserts at the beginning of a valid cycle on the IPIC. This signal used in conjunction with Bus2IP_RNW is especially suited for reading and writing to memory type devices.

Bus2IP_RdCE

Bus2IP_RdCE is a vector of a width that is the sum total of the values defined in C_ARD_NUM_CE_ARRAY. For each address pair defined in C_ARD_ADDR_RANGE_ARRAY a number of CE's can be defined in C_ARD_NUM_CE_ARRAY. Bus2IP_RdCE goes high coincident with Bus2IP_CS for read type transfers and is especially suited for reading registers.

Bus2IP_WrCE

Bus2IP_WrCE is a vector of a width that is the sum total of the values defined in C_ARD_NUM_CE_ARRAY. For each address pair defined in C_ARD_ADDR_RANGE_ARRAY a number of CE's can be defined in C_ARD_NUM_CE_ARRAY. Bus2IP_WrCE goes high when the write data is valid on Bus2IP_WrCE and is especially suited for writing to registers.

IP2Bus_Data

IP2Bus_Data is a vector of width C_SIPIF_DWIDTH and is the read data bus. Read data should be valid when IP2Bus_RdAck is asserted by the User IP.

IP2Bus_RdAck

IP2Bus_RdAck is the read data acknowledge signal. This signal is used by the User IP to acknowledge a read cycle and will cause read control signals, Bus2IP_RdCE, Bus2IP_CS and Bus2IP_RNW to de-assert.

Note 1: This signal should only be driven when read control signals are asserted. Driving IP2Bus_RdAck high when read control signals are NOT asserted will cause undefined results. What this means is that for a single beat transfer the User IP must drive IP2Bus_RdAck for only one Bus2IP_Clk cycle.

Note 2: During read cycles if the User IP does not acknowledge the read request within 128 Bus2IP_Clk cycles the slave attachment will timeout, de-assert the request to the User IP (i.e. de-assert Bus2IP_CS and Bus2ip_RdCE) and complete the read cycle on the PLB by driving sl_rddack with sl_rddbuss equaling all zeros.

IP2Bus_WrAck

IP2Bus_WrAck is the write data acknowledge signal. This signal is used by the User IP to acknowledge a write cycle and will cause write control signals, Bus2IP_WrCE, and Bus2IP_CS to de-assert.

Note 1: This signal should only be driven when write control signals are asserted. Driving IP2Bus_WrAck high when write control signals are NOT asserted will cause undefined results. What this means is that for a single beat transfer the User IP must drive IP2Bus_WrAck for only one Bus2IP_Clk cycle.

Note 2: During write cycles if the User IP does not acknowledge the write request within 128 Bus2IP_Clk cycles the slave attachment will timeout, de-assert the request to the User IP (i.e. de-assert Bus2IP_CS and Bus2ip_WrCE) and complete the write cycle on the PLB by driving sl_wrdack.

IP2Bus_Error

IP2Bus_Error is used by the User IP to indicate an error has occurred. This signal is only sampled with IP2Bus_WrAck or IP2Bus_RdAck and is ignored all other times. This signal should only be driven during read or write cycles.

IPIC Transaction Timing

The following section shows timing relationships for PLB and Slave Attachment interface signals during various read and write accesses.

Single Data Beat Read Operation (C_SPLB_P2P = 0)

Two single beat read cycles are shown in Figure 4. The first cycle shows the User IP data acknowledging (IP2Bus_RdAck = '1') the read cycle in the same clock cycle as Bus2IP_CS and Bus2IP_RdCE are presented. The second read is acknowledged by the User IP 3 clock cycles after the presentation of Bus2IP_CS and Bus2IP_RdCE. In either case Sl_rdAck and Sl_rdComp will be asserted in the next clock cycle after IP2Bus_RdAck is asserted by the User IP.

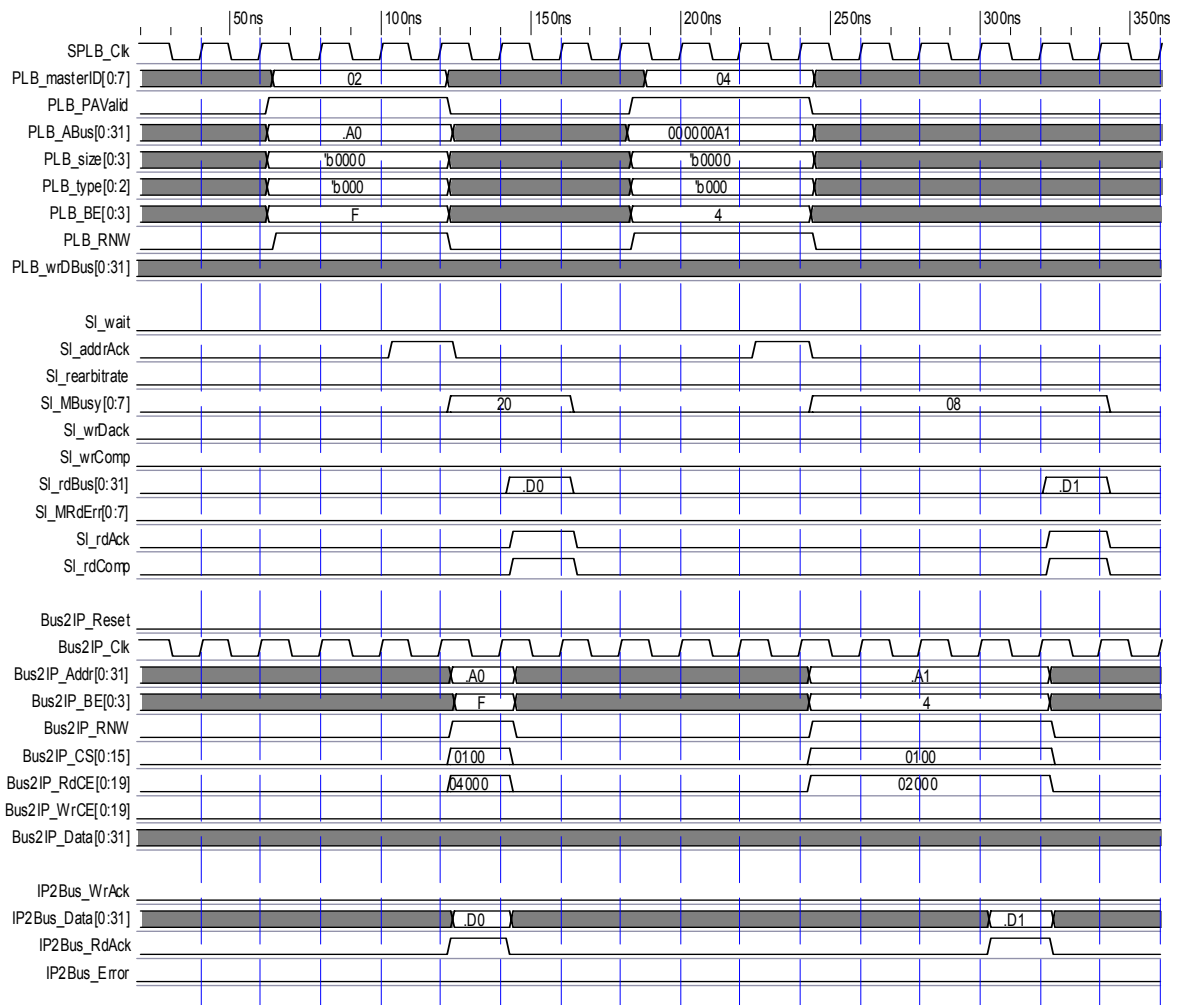

PLB Byte Read Target has 3 wait States

Figure 4: PLB Single Data Beat Read Timing (C_SPLB_P2P = 0)

Single Data Beat Write Operation (C_SPLB_P2P = 0)

Two single beat write cycles are shown in Figure 5. The first cycle shows the User IP data acknowledging (IP2Bus_WrAck = '1') the write cycle in the same clock cycle as Bus2IP_CS and Bus2IP_WrCE are presented. The second write is acknowledged by the User IP 3 clock cycles after the presentation of Bus2IP_CS and Bus2IP_WrCE. In either case Sl_wrAck and Sl_wrComp will be asserted in the next clock cycle after IP2Bus_WrAck is asserted by the User IP.

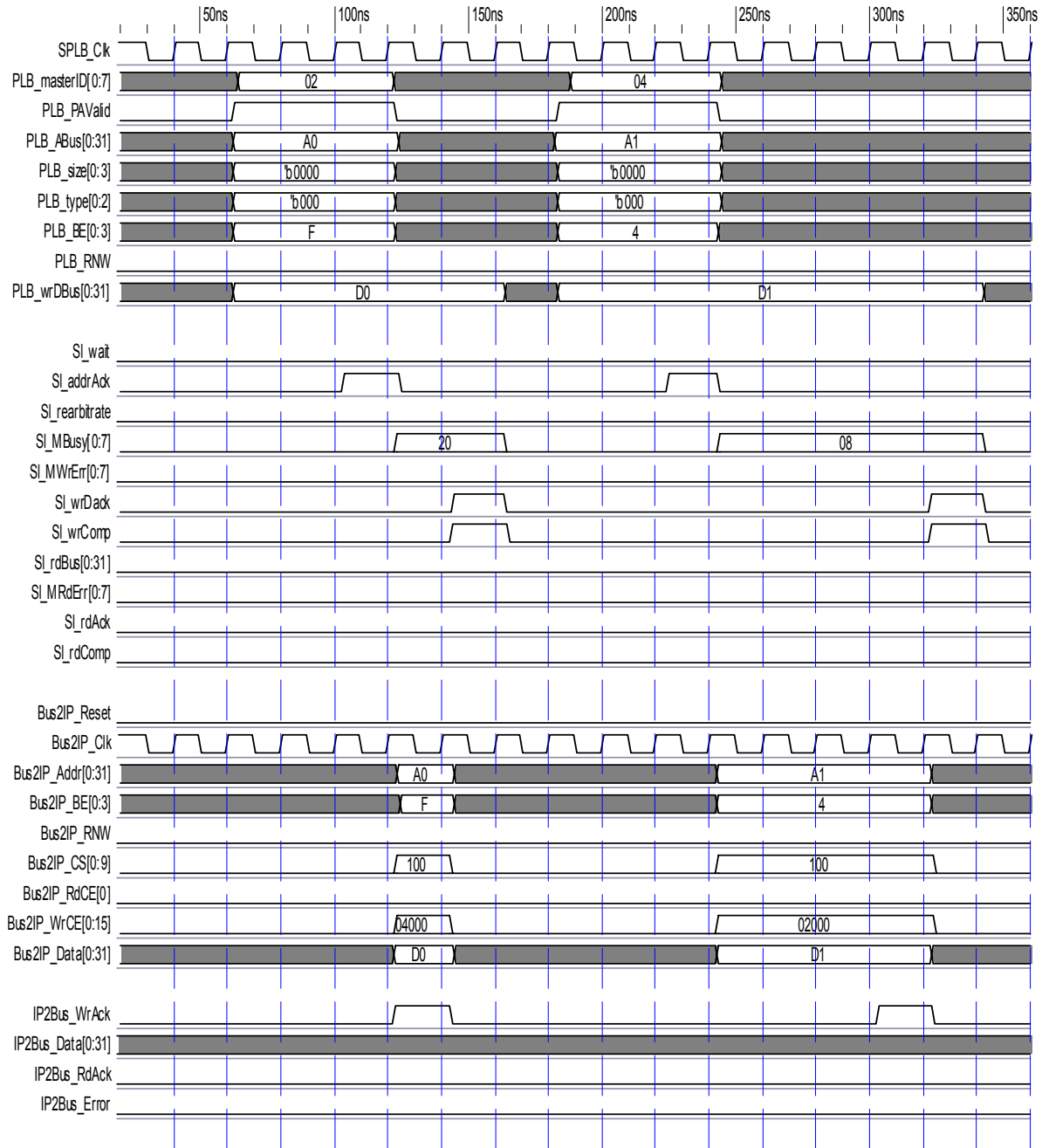

Figure 5: PLB Single Data Beat Write Timing (C_SPLB_P2P = 0)

Single Data Beat Back-to-Back Operation (C_SPLB_P2P = 0)

Figure 6 illustrates a back-to-back read/write cycle in a shared bus configuration. The slave attachment will issue a SI_rearbitrate on the write (second) cycle if the User IP is slow to respond. In the example shown the User IP drives IP2Bus_RdAck 1 clock after the presentation of Bus2IP_CS and Bus2IP_RdCE, thus forcing the second cycle to be rearbitrated

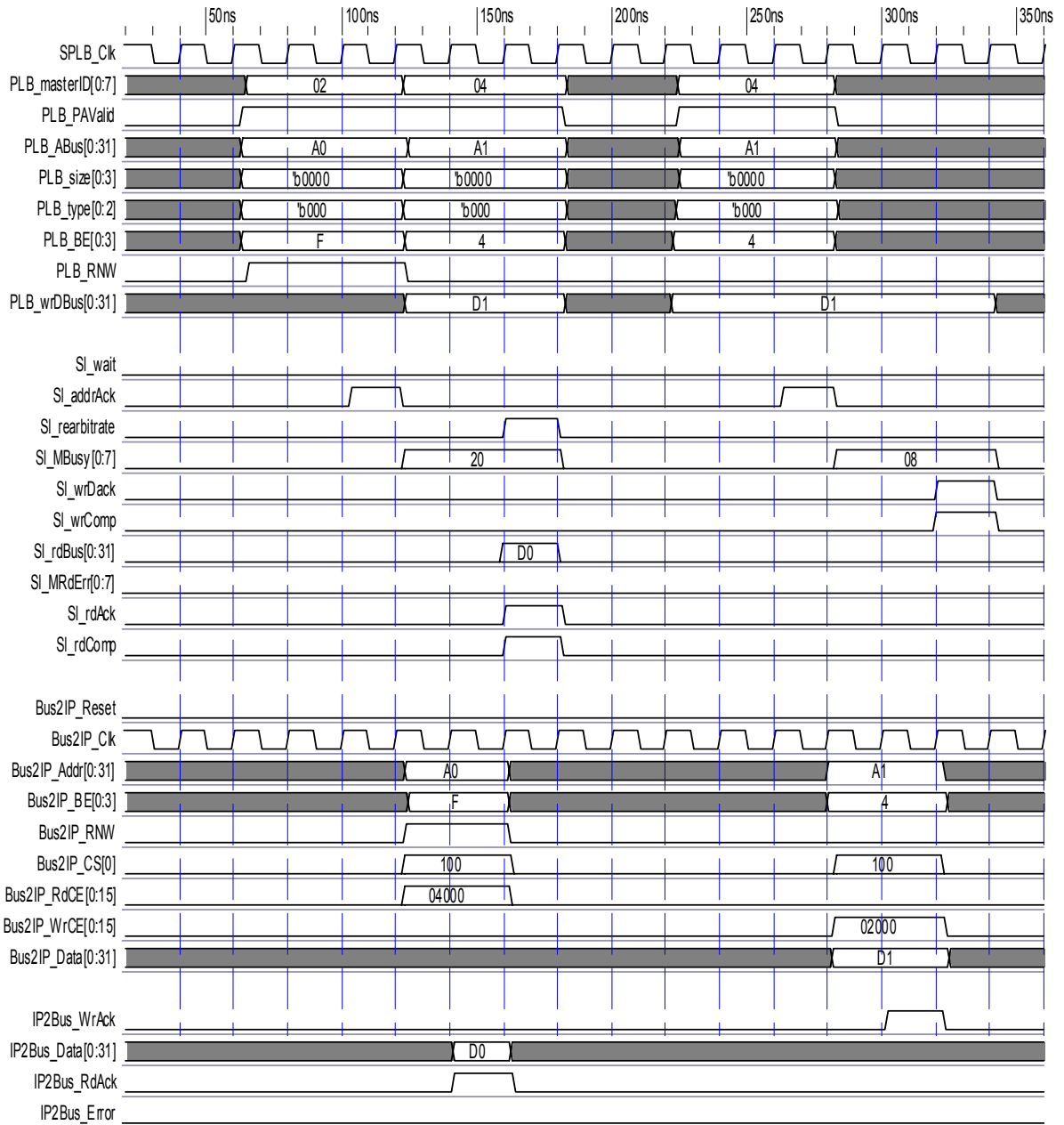
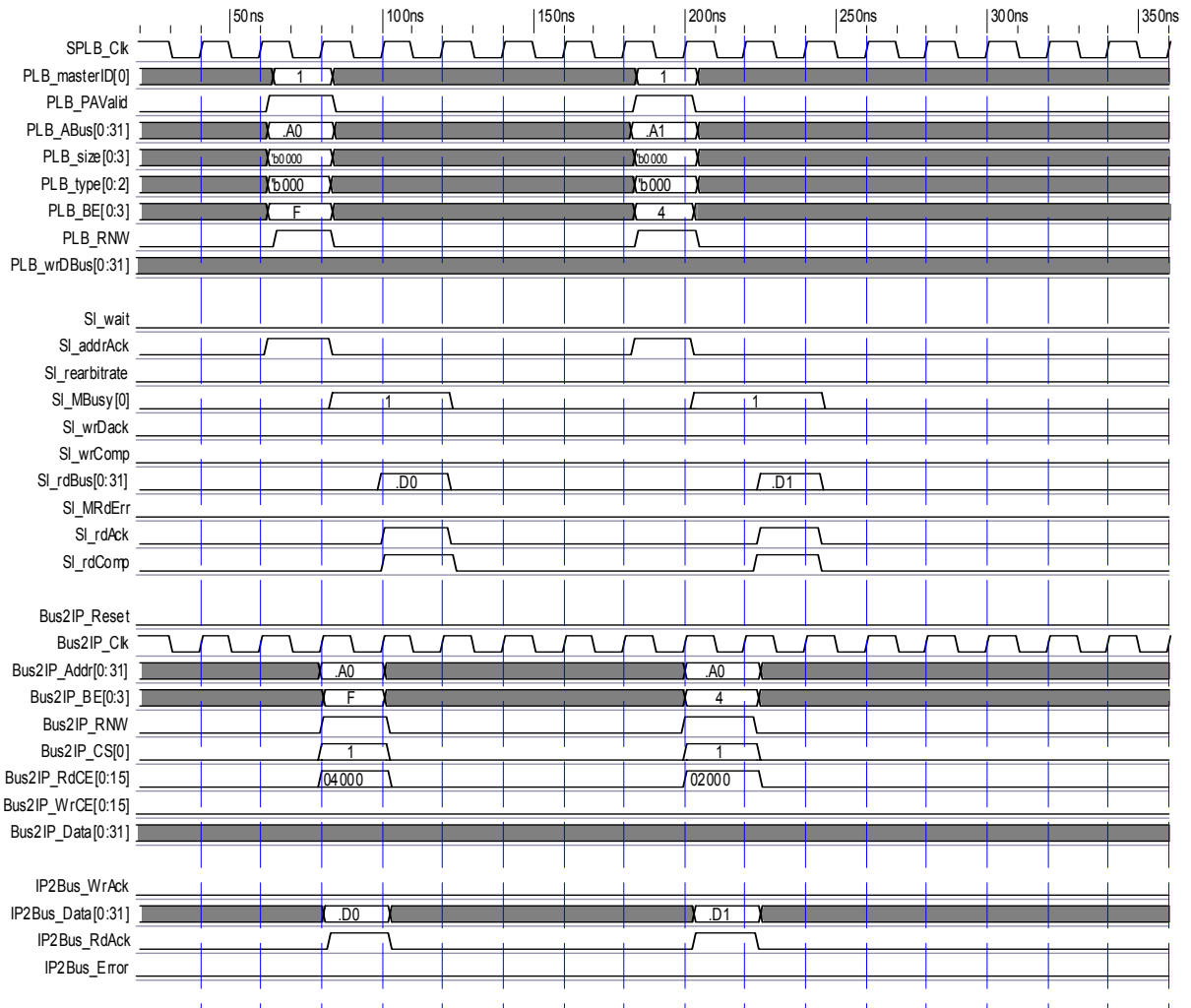

Figure 6: PLB Single Data Beat Back-to-Back Timing (C_SPLB_P2P = 0)

Single Beat Read Point-to-Point Operation (C_SPLB_P2P = 1)

In a point-to-point configuration, the cycle can be acknowledge on the same clock cycle as it is presented. This is shown in Figure 7, where SI_addrAck goes active in the same cycle as PLB_PAVValid. This reduces latency for read and write cycles.



PLB Byte Read Target has 3 wait States

Figure 7: PLB Single Data Beat Read Point-to-Point Timing (C_SPLB_P2P = 1)

Single Beat Write Point-to-Point Operation (C_SPLB_P2P=1)

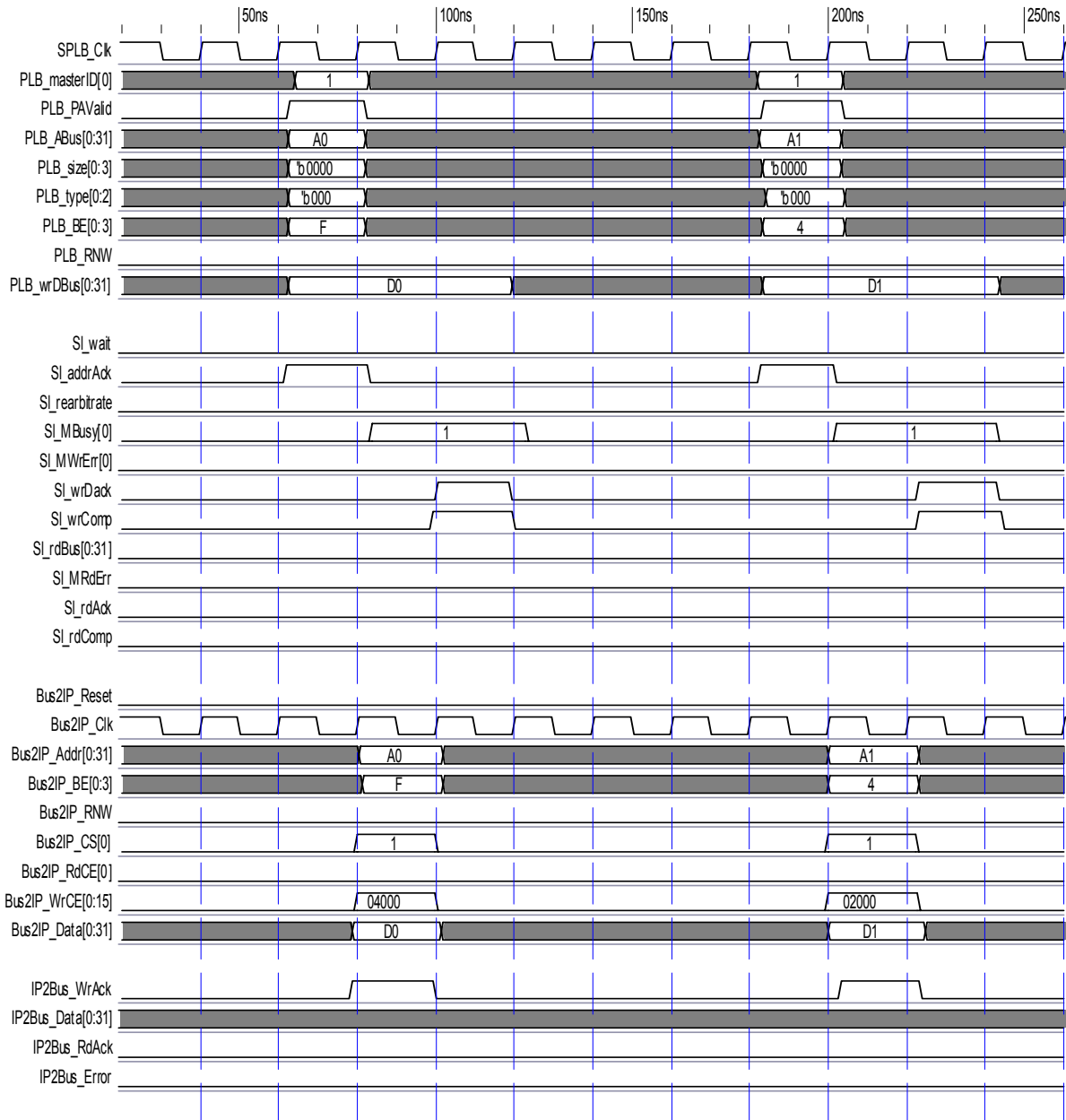
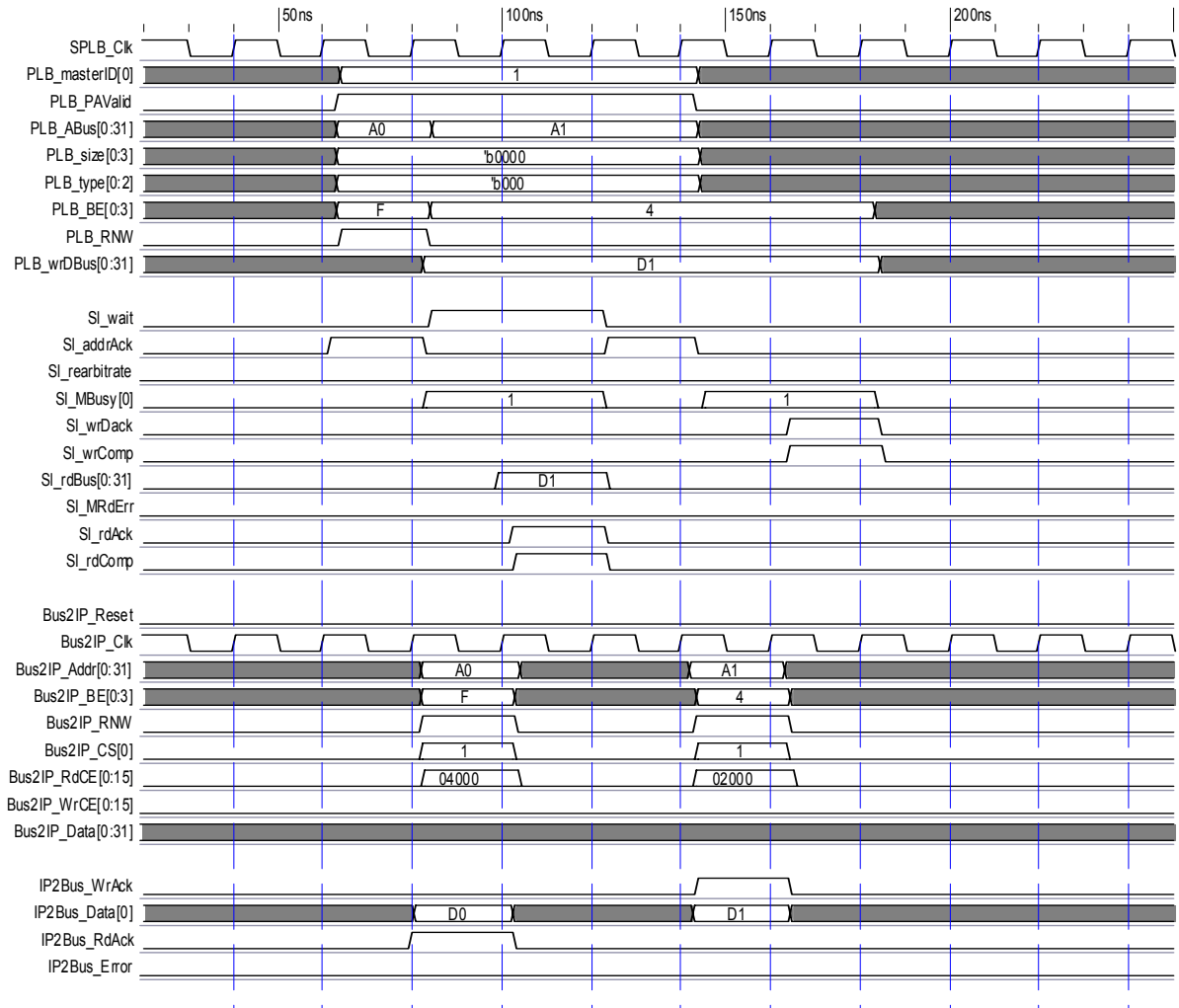

Figure 8: PLB Single Data Beat Write Point-to-Point Timing (C_SPLB_P2P = 1)

Single Data Beat Back-to-Back, Point-to-Point Operation (C_SPLB_P2P = 1)

Figure 9 shows two back-to-back read/write cycles from a master in a point-to-point PLB topology. After the first cycle is acknowledge by the slave attachment (SI_addrack='1'), SI_wait is driven high to hold off any address phase time-out while the first cycle is being handled by the slave. Upon completion of the first cycle the second cycle is acknowledge and handled by the slave.



PLB Byte Read Target has 3 wait States

Figure 9: PLB Single Data Beat Back-to-Back, Point-to-Point Read Timing (C_SPLB_P2P = 1)

Single Data Beat Read Error Operation (C_SPLB_P2P = 0)

Figure 10 shows a read error being generated by the User IP.

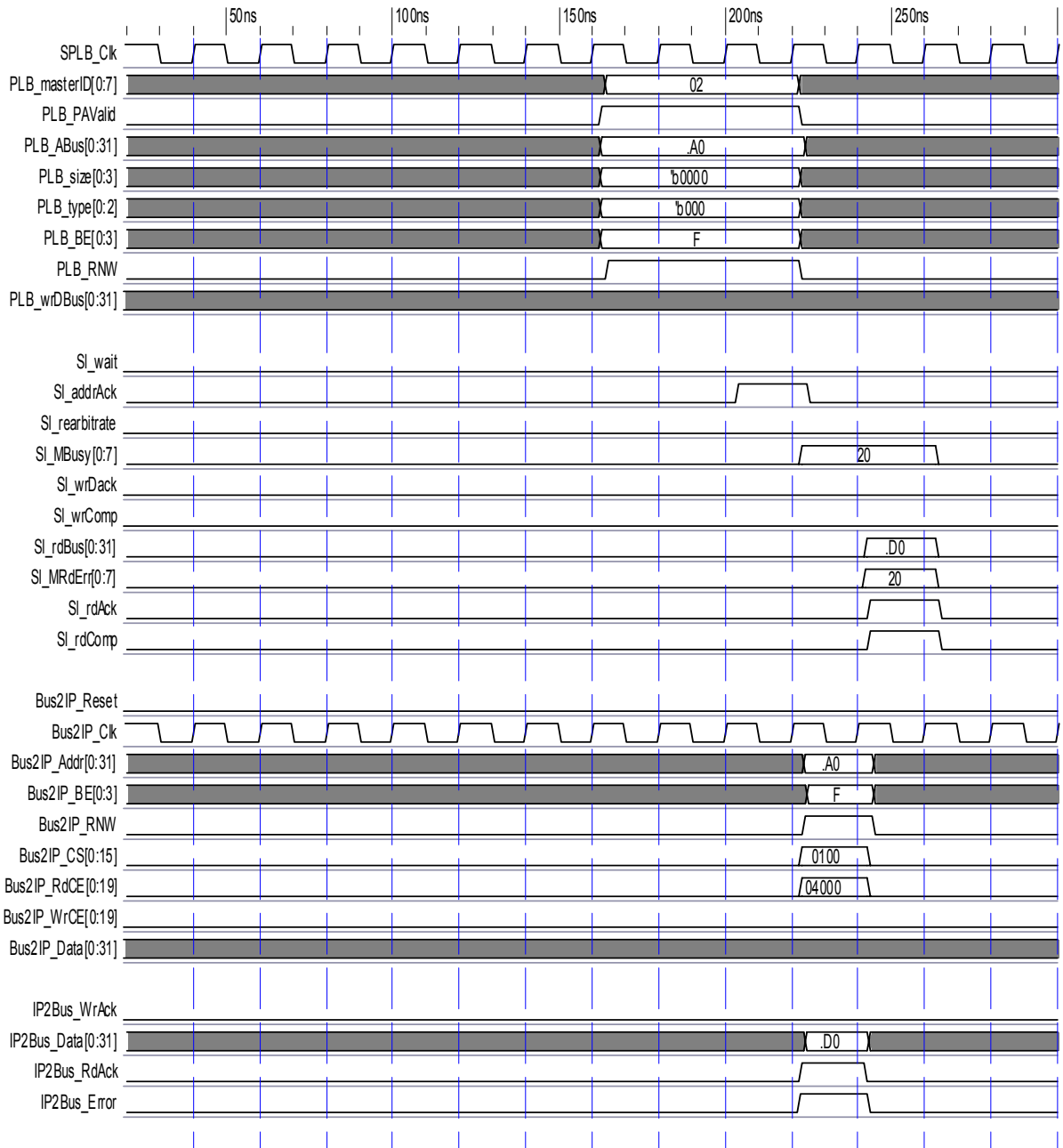

Figure 10: PLB Read Error Timing (C_SPLB_P2P=0)

Single Data Beat Write Error Operation (C_SPLB_P2P = 0)

Figure 11 shows a write error being generated by the User IP.

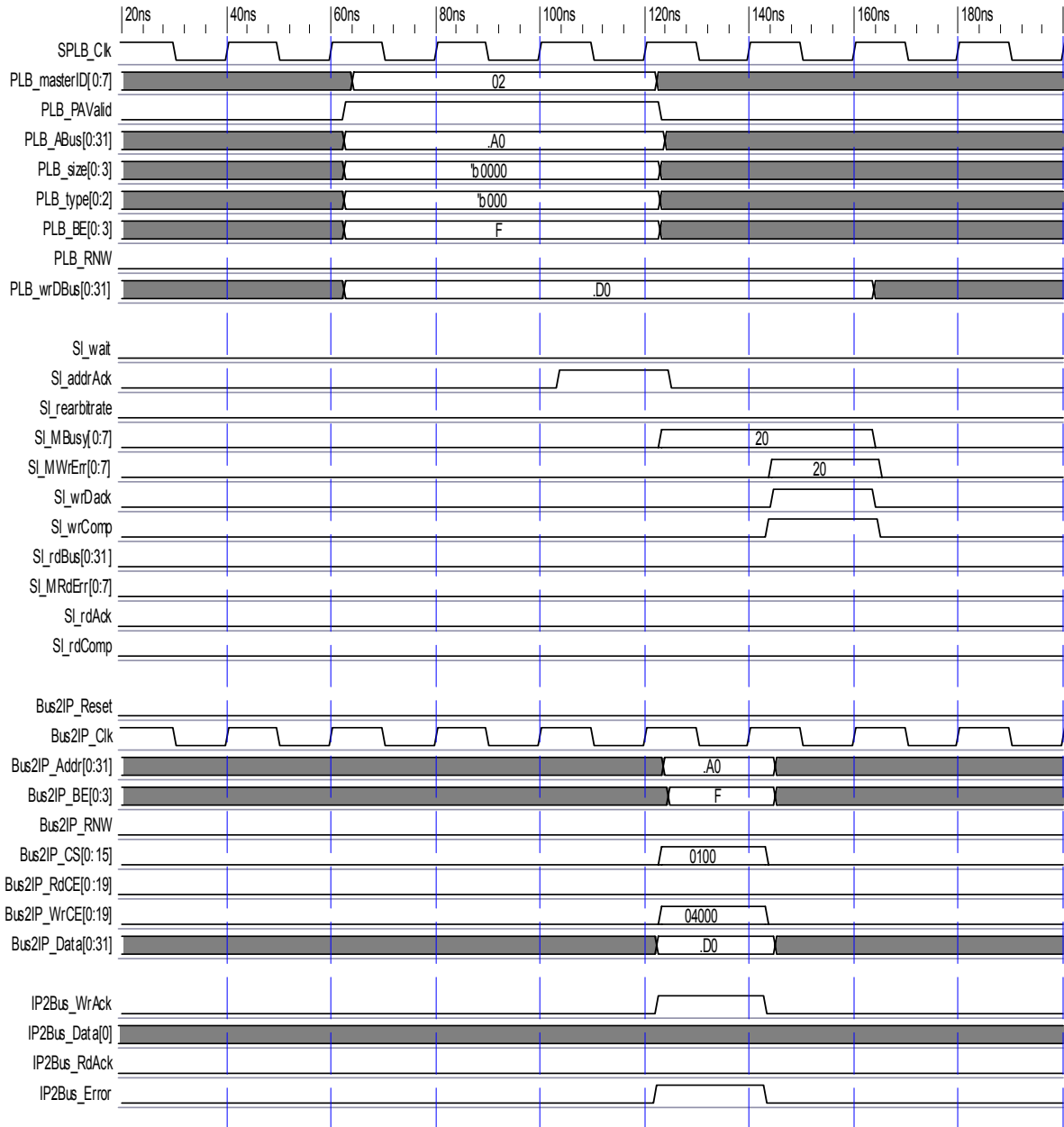

Figure 11: PLB Write Error Timing (C_SPLB_P2P=0)

User Application Topics

Understanding and Using IPIC Chip Selects and Chip Enables.

Implementing Chip Select (CS) and Chip Enable (CE) signals is a common design task that is needed within microprocessor based systems to qualify the selection of registers, ports, and memory via an address decoding function. The PLB Slave Attachment implements a flexible technique for providing these signals to Users via the ARD parameters. As such, the User must understand the relationship between the population of the ARD array parameters and the Bus2IP_CS, the Bus2IP_RdCE, and the Bus2IP_WrCE buses that are available to the User at the IPIC interface with the Slave Attachment. An example of ARD Array population and the resulting CS and CE bus generation is shown in [Figure 12](#). The timing characteristics of these signals are shown in the section titled "[IPIC Transaction Timing](#)" on [page 15](#). The signal set to use for User IP functions is up to the User and the design requirements. Unused CE and CS signals and associated generation logic will be 'trimmed' during synthesis and PAR phases of FPGA development.

Chip Select Bus (Bus2IP_CS(0:n))

A single Chip Select signal is assigned to each address space defined by the User in the ARD arrays. The Chip Select is asserted (active high) whenever a valid access (Read or Write) is requested of the address space and has been address acknowledged. It remains asserted until the data phase of the transfer between the Slave Attachment and the addressed target has completed. The User is provided the Bus2IP_CS port as part of the IPIC signal set. The Bus2IP_CS bus has a one to one correlation to the number and ordering of address pairs in the C_ARD_ADDR_RANGE_ARRAY parameter. For example, if the C_ARD_ADDR_RANGE_ARRAY has 10 entries in it, the Bus2IP_CS bus will be sized as 0 to 4. Bus2IP_CS(0) will correspond to the first address space, Bus2IP_CS(1) to the second address space, and so on. The nature of the Chip Select bus requires the User IP to provide any additional address discrimination within the address space as well as qualification with the Bus2IP_RNW signal.

Read Chip Enable Bus (Bus2IP_RdCE(0:y))

Bus2ip_RdCE is the chip enable bus for read transactions. Each address space defined in the ARD arrays are allowed to have 1 or more Chip Enables signals assigned to it. Chip Enables are used for subdividing an address space into smaller spaces that are each less than or equal to the PLB Bus width. Generally this is useful for selecting registers and ports during read or write transactions. The Slave Attachment allows the User to do this via parameters entered in the C_ARD_NUM_CE_ARRAY. For each defined address space, the User enters the number of desired Chip Enable signals to be generated for each space. Current implementation requires a value of at least 1 for each space. The data width of the space, set at 32-bits determines the size of the address slice assigned to each CE signal for the address space. Bus2ip_RdCE asserts if the request transaction is a read.

Write Chip Enable Bus (Bus2IP_WrCE(0:y))

The Bus2IP_WrCE bus is the same size as the Bus2IP_RdCE bus except that the Bus2IP_WrCE signals are only asserted if the requested transaction is a write.

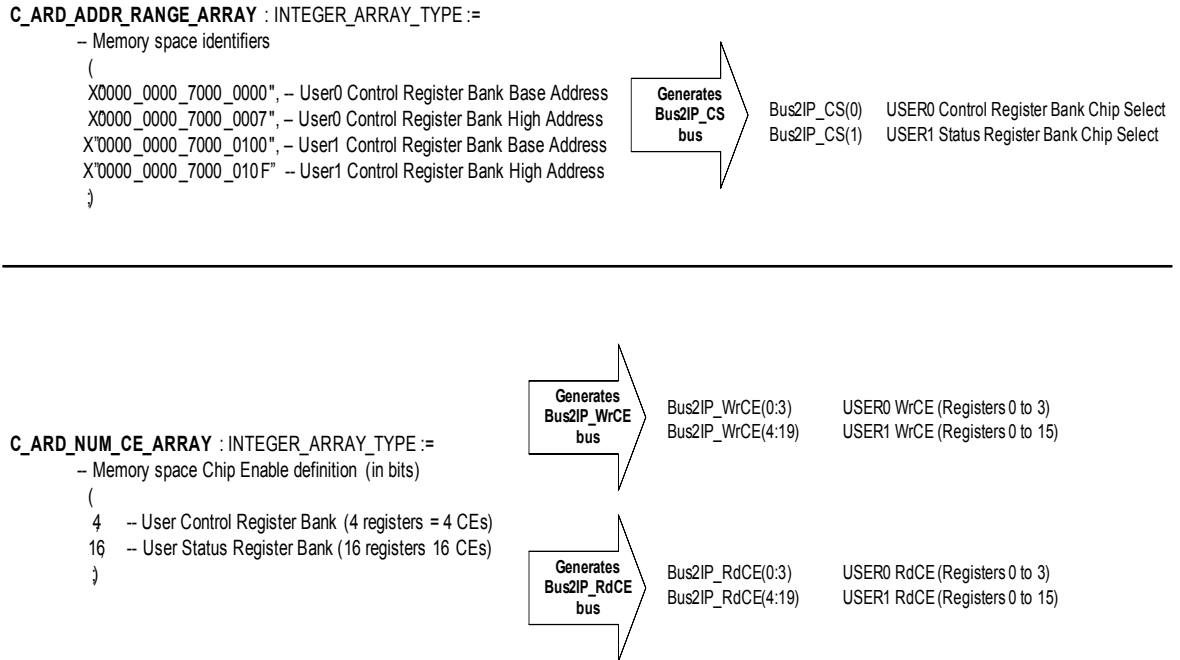

Figure 12: ARD Arrays and CS/CE Relationship Example

Available Support Functions for Automatic Ripping of CE and CS Buses.

The User may find it convenient to use some predefined functions developed by Xilinx to automatically rip signals from the Bus2IP_CS, Bus2IP_WrCE, and Bus2IP_RdCE buses. These functions facilitate bus ripping regardless of order or composition User functions in the ARD Arrays. This is extremely useful if User parameterization adds or removes User IP functions (which changes the size and ordering of the CS and CE buses). [Table 4 on page 25](#) lists and details these functions. These functions are declared and defined in the ipif_pkg.vhd source file that is located in the Xilinx EDK at the following path:

\EDK\hw\XilinxProcessorIPLib\pcores\proc_common_v2_00_a\hdl\vhd\ipif_pkg.vhd.

The following library declaration must appear in the User's VHDL source:

```

library proc_common_v2_00_a;
use proc_common_v2_00_a.ipif_pkg.all;

```

An example of how these functions are used is shown in [Figure 13](#).

Table 4: Slave Attachment Support VHDL Functions.

VHDL Function Name	Input Parameter Name	Input Parameter Type	Return Type	Description
calc_num_ce			Integer	This function is used to get the total number of signals that make up each of the Bus2IP_RdCE and the Bus2IP_WrCE buses (they are all the same size and order). The information is derived from the 'ce_num_array' parameter. Example: constant CE_BUS_SIZE : integer := calc_num_ce(C_ARD_NUM_CE_ARRAY);
	ce_num_array	INTEGER_ARRAY_TYPE		
calc_start_ce_index			Integer	This function is used to get the starting index of the CE or range of CEs to rip from the Bus2IP_RdCE and the Bus2IP_WrCE buses relating to the 'index' value of the address space entry in the ARD Arrays. The information is derived from the 'ce_num_array' parameter and an index of the address range of interest. Example: To find start ce index for the third address pair, pass 2 into the calc_start_ce_index function. constant USER0_START_CE_INDEX : integer := calc_start_ce_index(C_ARD_NUM_CE_ARRAY, 2);
	ce_num_array	INTEGER_ARRAY_TYPE		
	index	integer		

```

architecture USER_ARCH of user_top_level;

-- Extract the number of CEs assigned to the second address pair
Constant NUM_USER_01_CE : integer := C_ARD_NUM_CE_ARRAY(1);

-- Determine the CE indexes to use for the the second Register CE
Constant USER_01_START_CE_INDEX : integer := calc_start_ce_index(C_ARD_NUM_CE_ARRAY, 1);

Constant USER_01_END_CE_INDEX : integer := USER_01_START_CE_INDEX + NUM_USER_01_CE - 1;

-- Declare signals
signal user_01_cs : std_logic;
signal user_01_rdce : std_logic_vector(0 to NUM_USER_01_CE - 1);
signal user_01_wrce : std_logic_vector(0 to NUM_USER_01_CE - 1);

begin (architecture)

-- Now rip the buses and connect
user_01_cs <= Bus2IP_CS(1);
user_01_rdce <= Bus2IP_RdCE(USER_01_START_CE_INDEX to USER_01_END_CE_INDEX);
user_01_wrce <= Bus2IP_WrCE(USER_01_START_CE_INDEX to USER_01_END_CE_INDEX);

```

Figure 13: Bus Ripping Example

Point-To-Point Configuration

A Point-To-Point configuration is defined as 1 Master talking to 1 Slave over the PLB Bus. If the PLB topology is configured such that it is a Point-To-Point configuration then some of the FPGA resource utilization can be reduced as well as some of the latency through the slave (See Figure 13 through Figure 14). To accomplish this the user must set `C_SPLB_P2P = 1`.

Single Address Pair in `C_ARD_ADDR_RANGE_ARRAY`

For situations where the User does not require additional slave services then 1 address pair should be defined in `C_ARD_ADDR_RANGE_ARRAY`. The address pair should span the entire address range of the system. For example, set the base address to `X"0000_0000_0000_0000"` and set the high address to `X"FFFF_FFFF_FFFF_FFFF"`.

Multiple Address Pair in `C_ARD_ADDR_RANGE_ARRAY`

For situations where other slave services are required, such as interrupt control and/or soft reset services, then the user will need to define multiple address pairs in `C_ARD_ADDR_RANGE_ARRAY`. If the user defines multiple address pairs in `C_ARD_ADDR_RANGE_ARRAY` then from a system perspective the PLB Bus starts looking like a shared bus, i.e. one having multiple Slaves. For this configuration the bus no longer represents a point to point configuration. In other words the address decode logic must be instantiated in the Slave Attachment to decode the multiple address ranges. When multiple address pairs are defined in `C_ARD_ADDR_RANGE_ARRAY` and `C_SPLB_P2P = 1` the Slave Attachment latency will be the same as if

there was only 1 address pair defined in C_ARD_ADDR_RANGE_ARRAY, but some of the LUT savings of the Point-To-Point mode will not be realized.

For this situation the user should set the base address and high address for the services starting at X"0000_0000_0000_0000". The Users IP should then follow the service address ranges and have a high address of X"FFFF_FFFF_FFFF_FFFF". (See [Figure 14](#))

```

C_ARD_ADDR_RANGE_ARRAY : SLV64_ARRAY_TYPE :=
  -- Base address and high address pairs .
  (
    X0000_0000_7000_0000", -- user control reg bank base address
    X0000_0000_7000_0007", -- user control reg bank high address
    X0000_0000_7000_0100", -- user status reg bank base address
    X0000_0000_7000_010F"  -- user status reg bank high address
  )

```

In this example, there are two address pairs entered into the C_ARD_ADDR_RANGE_ARRAY VHDL Generic. This corresponds to the two address spaces being defined by the user . Each pair is comprised of a starting address and an ending address . Values are right justified and are byte address relative .

Figure 14: C_ARD_ADDR_RANGE_ARRAY for Point-To-Point Configuration

Note that the Slave Attachment will not acknowledge and address if it falls outside of an address range defined in C_ARD_ADDR_RANGE_ARRAY. For example, if C_ARD_ADDR_RANGE_ARRAY is defined as in [Figure 14](#) and a master attempts to read or write to address 0x80 then the Slave attachment will NOT acknowledge the cycle.

Data Phase Timeout

A data phase timeout function has been incorporated into the plbv46_slave_single to provide a means to complete a PLB request even when the User IP does not respond with an IP2Bus_RdAck or IP2Bus_WrAck. If C_INCLUDE_DPHASE_TIMER = 1 and after 128 SPLB_Clk cycles, as measured from the assertion of SI_AddrAck, the User IP does not respond with either an IP2Bus_RdAck or IP2Bus_WrAck the plbv46_slave_single will de-assert the User IP cycle request signals, Bus2IP_CS and Bus2IP_RdCE or Bus2IP_WrCE, and will assert SI_rdDAck with SI_rdDBus=zero for a read cycle or SI_wrDAck for a write cycle. This will gracefully terminate the cycle. Note that the requesting master will have no knowledge that the data phase of the PLB request was terminated in this manner.

FPGA Design Application Hints

Single Entry in Unconstrained Array Parameters

Synthesis tools sometimes have problems with positional association of VHDL unconstrained arrays that have only one entry. To avoid this problem, the User should use *named association* for the single array entry. This is shown in the following example:

```
C_ARD_NUM_CE_ARRAY(16); -- VHDL positional association...may cause synthesis type conflict error for single entry!
```

```
C_ARD_NUM_CE_ARRAY(0 => 16); -- VHDL named association...avoids type conflict error for single entry.
```

Register Descriptions

The plbv46_slave_single has no internal registers.

Design Implementation

Target Technology

The intended target technology is a Spartan-3, Virtex-4 and Virtex-5 FPGA.

Device Utilization and Performance Benchmarks

Since the plbv46_slave_single is a module that will be used with other design modules in the FPGA, the utilization and timing numbers reported in this section are just estimates. As the plbv46_slave_single is combined with other pieces of the FPGA design, the utilization of FPGA resources and timing will vary from the results reported here.

The resource utilization of this version of the plbv46_slave_single is shown in [Table 5](#) for some example configurations. The Slave Attachment was synthesized using the Xilinx XST tool. The XST resource utilization report was then used as the source data for the table.

The plbv46_slave_single benchmarks are shown in [Table 5](#) for a xc5vlx220-2-ff1760 FPGA.

Table 5: PLBV46_Slave_Single FPGA Performance and Resource Utilization Benchmarks

Parameter Values				Device Resources			$f_{MAX}^{(1)}$
$C_ARD_ADDR_RANGE_ARRAY$ Pairs	$C_ARD_NUM_CE_ARRAY$	C_SPLB_DWIDTH	C_SPLB_P2P	Slices	Slice Flip-Flops	4-input LUTs	$f_{MAX}^{(1)}$
1	1	32	1	37	91	27	167.8 MHz
1	1	32	0	71	173	32	214.8 MHz
1	2	32	0	63	176	34	178.8 MHz
1	4	32	0	57	181	40	173.1 MHz
2	4,4	32	0	83	191	55	178.8 MHz
2	4,4	64	0	70	191	59	183.4 MHz
2	4,4	128	0	88	191	59	177.7 MHz

Notes:

1. Fmax represents the maximum frequency of the PLBV46 Slave Single in a standalone configuration. The actual maximum frequency will depend on the entire system and may be greater or less than what is recorded in this table.

Specification Exceptions

The following High Level PLB features are **not** supported by the plbv46_slave_single Slave function.

- Bus Master
- Split Bus Transactions
- Address Pipelining
- Abort Transactions
- Fixed Burst
- Indeterminate Burst
- Cacheline

Reference Documents

The following documents contain reference information important to understanding the PLB Slave Attachment design.

- IBM CoreConnect™ *128-Bit Processor Local Bus, Architectural Specification* (v4.6).

Revision History

Date	Version	Revision
5/14/2008	1.0	Initial Xilinx release.
9/17/2008	1.1	Updated resource utilization and performance numbers
10/3/2008	1.2	Added clarity to the IP2Bus_RdAck and IP2Bus_WrAck signal descriptions to emphasize that these signals must only be asserted for 1 Bus2IP_Clk cycle.